

VL2600 SE WASH

Date: _____

Type: _____

Firm Name: _____

Project: _____

The VL2600 SE Wash is an upgraded version of the iconic workhorse fixture with a powerful new 570W light engine, offering 27,500 lumens of output and the most versatile range of wash looks in its class. With the VL2600 SE Wash, designers can achieve more wash looks from a single fixture thanks to a wide zoom range, adjustable beam edge softness, and a built-in automated barn door system as standard. This powerful, versatile wash luminaire offers excellent light quality, a broad color palette, and a wide range of features, making it a highly specified around the world for tours, theatrical and television productions, theatrical and house of worship installations, and more.



- High-output, mid-sized profile luminaire – versatile workhorse fixture
- Excellent quality of light and flat, even beam – get the perfect look every time
- Full wipe framing shutter – smooth framing automated barn door system
- Wide 12° to 63° zoom range – broader wash coverage options from a single fixture

- Adjustable beam edge softness – select a Fresnel or pebble convex (PC) for the perfect wash look every time
- CMY color mixing, fixed color wheel (7 + open), and variable CTO – broad color range and adjustable color temperature

For detailed product information, please refer to the Product Guide at <https://www.vari-lite.com/global/products/vl2600-wash>



VARI*LITE

Specifications

Due to continuous improvements and innovations, specifications may change without notice.

Source

ESE LED System	Monochromatic Light Engine
Source Max Power Consumption	570 W
Source Lumens	44500
Source CCT	8000 K
LED Refresh Rate	500Hz to 25KHz
Dimming	Electronic 16-bit
Dimmer Curves	Square Law (Default), Linear, S -Curve
Dimmer Control Option	Dimmer Snap On/Off On Increases speed of mechanical shutter override of glass dimmer
Strobe Speed	0 - 30Hz
Strobe Modes	Continuous, Random, Random Sync

Optical Performance

Lens Size	180 mm (7.0 in)
Zoom Range	12 - 63°
Zoom Control	Motorized 16-Bit
Focus	Motorized 16-Bit Control
Output Lumens	Standard - 27,500
Output CCT	7200 K
CRI RA	74
Tm30	Rf 69 / Rg 95

Color System

Subtractive Color Mixing	CMY Glass Flags
Color Mixing Control	CMY 8-bit
Color Mixing Control Option	Color Snap On/Off On reduces auto smoothing color to create faster color changes
Variable CTO	7200 to 3200 K
Fixed Color Wheel	7 Colors + Open
Color Wheel Effects	Split Colors, Color Wheel Spin, and Shake

Imaging

Framing Shutters	4 Blade - Full Wipe +/-90° rotation
Beam Softening	PC to Fresnel

Electrical

Max output Power Consumption	820 W
Power Connection	Neutrik TrueOne - In / Thru Power cable not included - input connector only
Input Voltage	100–240 VAC, 50 / 60 Hz

Data

Supported Protocols	DMX (RDM), ArtNet
DMX Modes	
16-Bit Enhanced	32 Channels
16-Bit	29 Channels
Data Connections	5 - PIN XLR Input & Thru, RJ45 Input
Manual Mode	On Board local Control

Noise Level / Fan Control (Base Level 30 dB)

Standard Mode	48.5 dB
Studio Mode	43 dB
Silent Mode (UI Activation Only)	31 dB
Fan Mode	Continuous (On) / Auto Ramping
Fan Level Preset	Standard / Studio / Silent* (*UI Only)
Cooling System Type	Hybrid sealed liquid and forced air system

Movement

Pan Angle	540°
Pan Speed	3.4 s
Tilt Angle	270°
Tilt Speed	2.5 s

Mounting

Hanging Type	2 x V/L Hook Rails
Hanging Centers	600.0 mm (24.0 in)
Fixture mounting/Hanging orientation	Hanging - Floor - Side *See user manual for side hang guidance and restrictions
Secondary Safety Wire Point	1 x Safety point located on underside of upper enclosure Safety Wire not included

Photometrics and IES Files

For IES files and photometric reports, please refer to the product page:
<https://www.vari-lite.com/global/products/vl2600-wash>

Dimensions

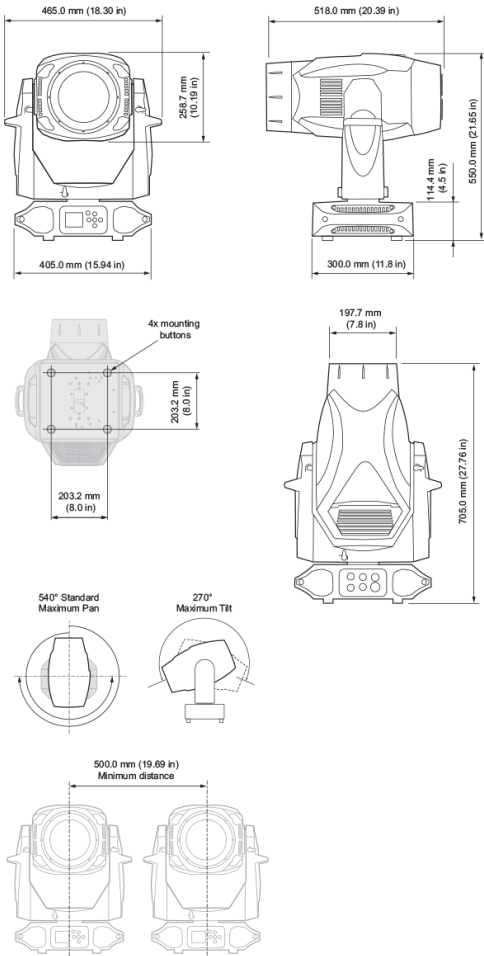

Physical

Construction	Superstructure made of Aluminum, and steel metal plates, Covers self-extinguishing fire retardant ABS PC (V0 class)
IP Rating	IP20
Standard	Black, White
Finish	
Dimensions	300 x 464 x 705 mm (12.0 x 18.0 x 29.0 in)
Fixture Weight	30.0 kg (67.0 lb)

Certification and Safety

Approbations	CE, ETL, UL, FCC CSA, RoHS, ISO 9001
--------------	--------------------------------------

Luminaire and Accessories

Product type	Order Code
VL2600 SE, Wash Black	74802-003
VL2600 SE, Wash White	74802-103

Accessories	
GT Truss Rail	22.9708.0835
VL Hanging Rail, 1 x GT Truss drop rail, c/w VL1600, VL4000, VL2600, VLZ series and VL10,	



© 2024 Signify Holding. All rights reserved. All trademarks are owned by Signify Holding or their respective owners. The information provided herein is subject to change, without notice. Signify does not give any representation or warranty as to the accuracy or completeness of the information included herein and shall not be liable for any action in reliance thereon. The information presented in this document is not intended as any commercial offer and does not form part of any quotation or contract, unless otherwise agreed by Signify. Data subject to change.

Vari-Lite
<https://www.vari-lite.com/global/products/M2600-wash>